

LAV

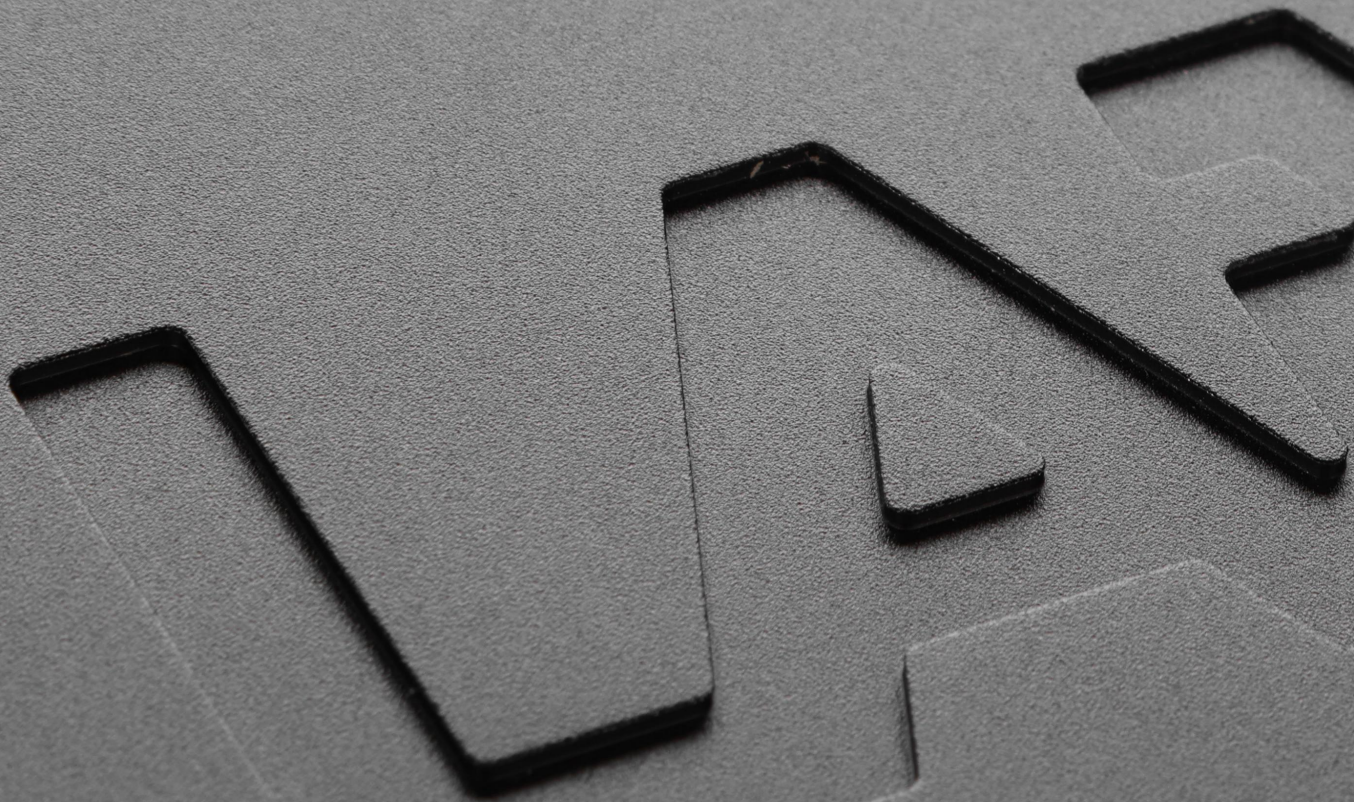

HARMONY μ DAC | Manual

V1.1



TABLE OF CONTENTS

| | |
|--|-----------|
| 1. Getting Started | 4 |
| 1.1. Introduction | 4 |
| 1.2. Safety Instructions | 5 |
| 1.3. Quick Start | 6 |
| 2. Basics About The μDAC | 7 |
| 2.1. The Front Panel | 7 |
| 2.2. The LED Display | 8 |
| 2.3. The Rear Panel | 9 |
| 3. Settings For The μDAC.398 | 10 |
| 3.1. Selecting Input Sources | 10 |
| 3.2. Settings Menu | 12 |
| 3.3. NOS/OS and Phase Mode | 13 |
| 3.4. Remote Control | 15 |
| 3.5. Display Brightness and Delay Setting | 16 |
| 3.6. Display Information Setting | 17 |
| 3.7. I ² S Mode | 18 |
| 3.8. I ² S Clock | 19 |
| 3.9. I ² S DSD L/R Swap | 19 |
| 3.10. Auto Power On Setting | 20 |
| 3.11. “About” In The Settings | 20 |
| 3.12. Factory Reset | 20 |
| 4. Technical Specifications | 21 |
| 5. Warranty and Contact Information | 24 |
| 5.1. Warranty Terms | 24 |
| 5.2. Contact Information | 25 |



1. Getting Started

1.1. Introduction

Thank you for joining the Laiv community—a warm welcome to you! We're absolutely thrilled to have you with us on this journey, where we're dedicated to turning your dreams into reality. It's truly an honor to support your pursuit of premium sound quality with our products. Welcome aboard!

Allow us to introduce our new μ DAC, thoughtfully crafted with a sleek and compact design to fulfill every audiophile's desire and dream. Drawing on our expertise in the audio industry, we've seamlessly combined the best features to create the μ DAC that redefines design, performance, and usability.

Welcome aboard—we're excited to share this audio adventure with you!



1.2. Safety Instructions

We're thrilled to have you as part of our family, and your safety is our utmost priority. Before you dive into using your new μ DAC, let's go over some essential safety tips to ensure everything goes smoothly:

- 1) **Get to Know Your μ DAC:** Take a moment to flip through the user manual. It's packed with handy information about how to use your μ DAC safely and effectively.
- 2) **Stay Dry and Grounded:** Keep your μ DAC away from water sources and damp areas. Remember, electricity and water don't mix well! And always use grounded outlets to avoid any shocking situations.
- 3) **Keep it Cool:** Your μ DAC needs space to stay cool. Make sure there's plenty of airflow around it. Avoid placing your μ DAC in direct sunlight or near heat sources like radiators or stoves. Extreme heat can damage delicate components and shorten the lifespan of your μ DAC.
- 4) **Keep it Clean, Keep it Safe:** Regular cleaning is key to keeping your μ DAC happy. But remember, gentle is the name of the game—no harsh chemicals or scrubbing, please!
- 5) **Hands Off the Repairs:** If your μ DAC starts acting up, don't go all DIY hero on it. Leave the fixes to the pros. They've got the skills and know-how to get things back in working order safely.
- 6) **Keep it Kid-Safe:** Little ones are curious creatures, so make sure to keep cords and plugs out of their reach. And always supervise their interactions with μ DAC to avoid any unplanned experiments!
- 7) **Power Down for Peace of Mind:** When you're done using your μ DAC, hit the off switch. It's a simple step that can prevent any unwanted surprises while you're away.
- 8) **Trust Your Instincts:** If something seems off—smoke, sparks, strange noises—don't ignore it! Shut off the power and reach out to us or a professional for help ASAP.
- 9) **Safety First, Always:** Remember, your safety comes above all else. Take your time, follow these tips, and enjoy using your μ DAC with confidence!

If you ever have any questions or concerns about using your μ DAC safely, don't hesitate to reach out. We're here to help you every step of the way!

1.3. Quick Start

1

Sit back, relax, and coffee.

Register
Extended
WarrantyRead
Guide**2**Connect all the cables, turn it on,
and you're ready to rock and roll!



2. Basics About The μ DAC

2.1. The Front Panel

All the information and controls can be accessed using the front panel of the μ DAC. The controls on the front panel are similar to those of the IR remote control, providing a seamless experience for controlling the device.

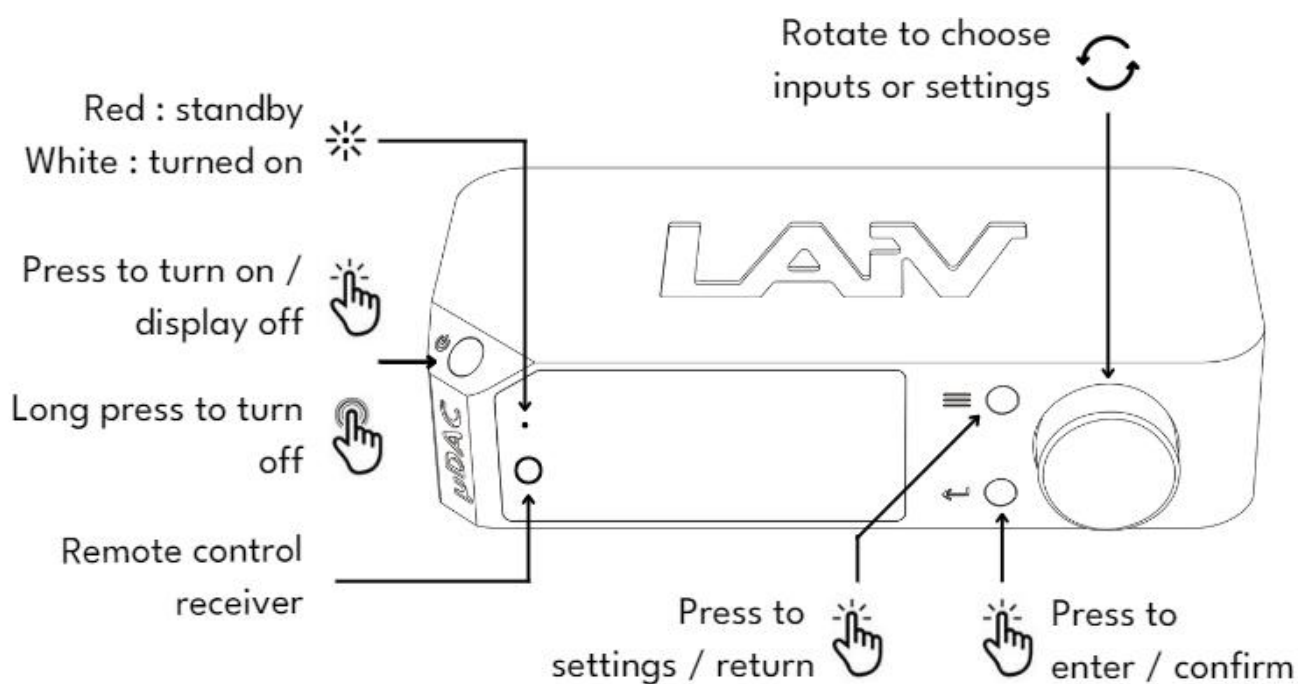

2.2. The LED Display

Experience the intuitive LED Running Text Display, showcasing up to five characters. Its user-friendly interface ensures seamless navigation and quick access to settings, offering unmatched convenience.

Indicates the settings menu. Press the Enter button to access and explore other options within this setting.

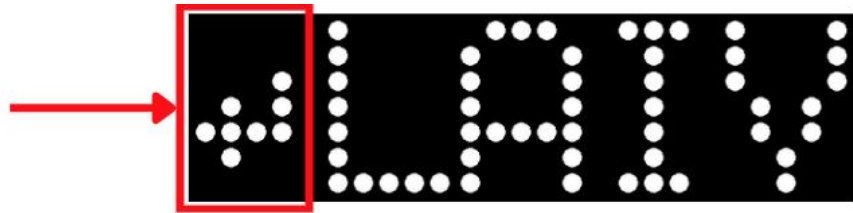

Indicates the unselected setting. Press the Enter button to select this setting. Turn the dial to navigate to other setting.

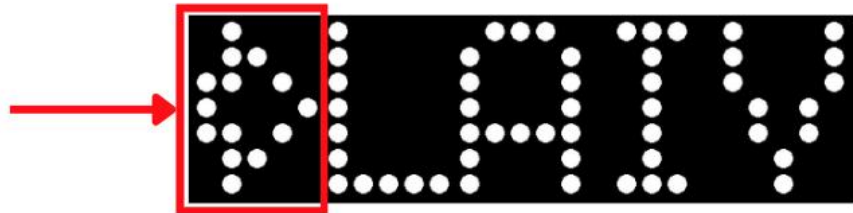

Indicates the selected setting. Turn the dial to navigate to view other setting.

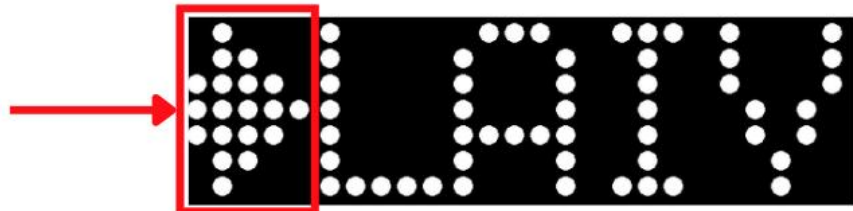

2.3. The Rear Panel

The rear panel of the μ DAC features distinct sections for input and output. Positioned on the far right is the DC Power inlet, providing power to the device. Moving towards the center, you will find the array of digital inputs, including USB, OPT (optical), COAX (coaxial), and I²S, offering versatile connectivity options to suit various audio sources. Finally, on the left side, are the balanced XLR analog output, allowing you to seamlessly connect the μ DAC to your amplifiers or other audio equipment for exceptional sound reproduction.

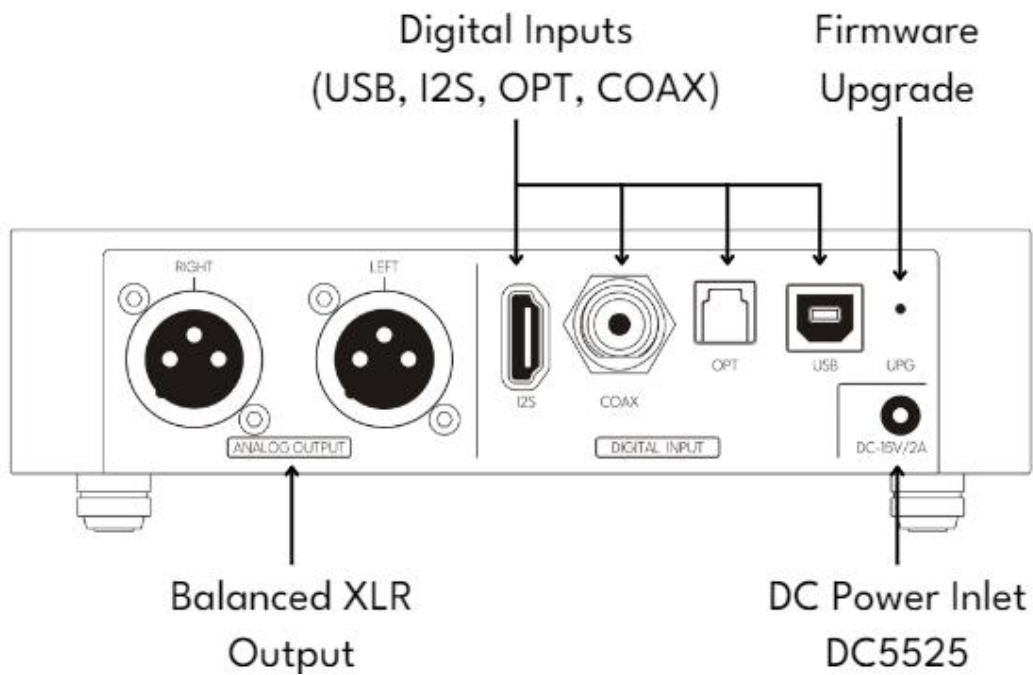



3. Settings For The μ DAC.398

3.1. Selecting Input Sources

The μ DAC offers four distinct inputs, each catering to different connectivity needs. Whether it's USB, optical, coaxial, or I²S, you have the flexibility to choose the input that suits your setup best. To switch between inputs, simply turn the dial located on the right front side of the μ DAC. The display will indicate the currently selected input; continuing to turn allows you to navigate to other options as needed. Once the desired input is displayed, press the Enter button to confirm the selection and return to the main page for uninterrupted audio enjoyment.

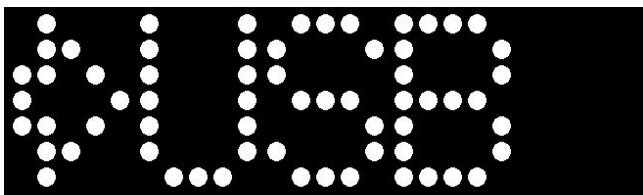

USB Input

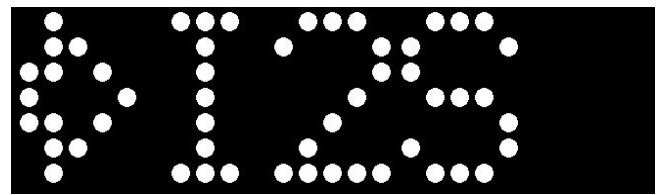

I²S Input

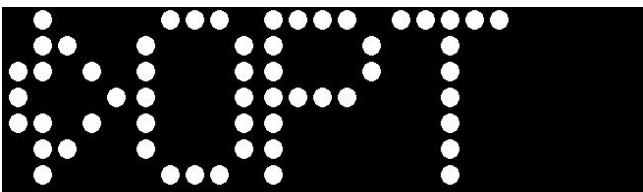

OPTICAL Input

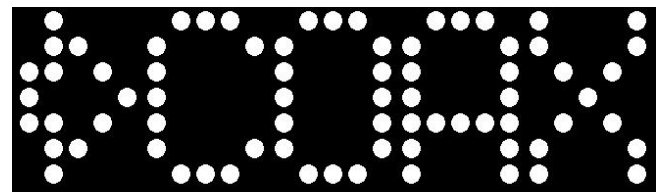

COAXIAL Input

Indicates the selected input source. Turn the dial to navigate to view other input sources and press enter to select the other input source.

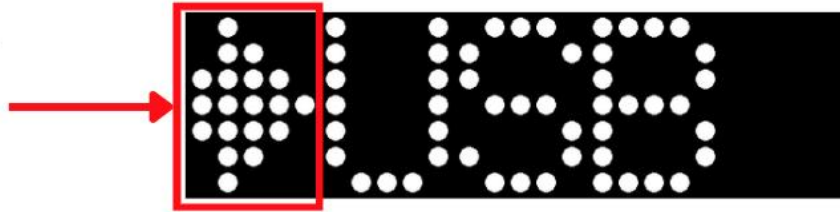

If the selected input source is not available, the display will show 'No Signal'. You need to select the correct input source to enjoy the music with the Harmony μ DAC.

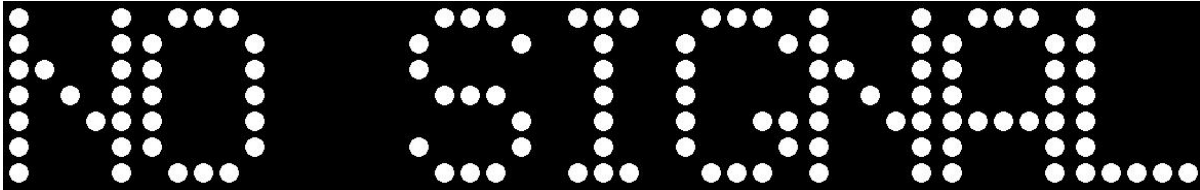

3.2. Settings Menu

Our settings menu serves as the central hub for configuring all aspects of your μ DAC experience. Easily accessible via the menu button on the front panel or through the convenience of the remote control, this intuitive interface puts control at your fingertips. Whether adjusting audio preferences, fine-tuning connectivity options, or customizing display settings, our settings menu provides seamless navigation and effortless customization to tailor your audio experience to perfection.

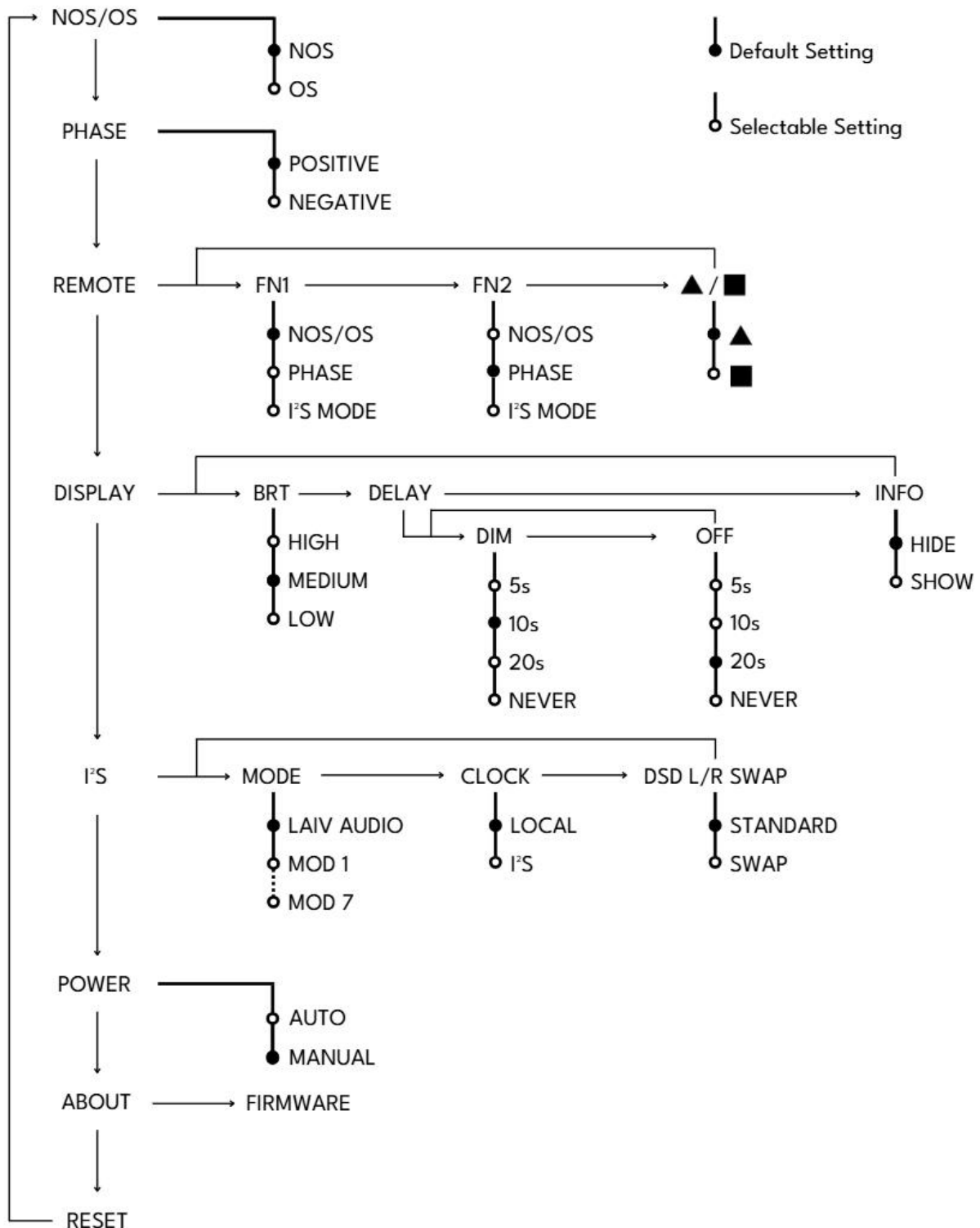

3.3. NOS/OS and Phase Mode

The μ DAC is a versatile audio solution designed to elevate your listening experience. With Harmony μ DAC, you not only have the flexibility to choose between Non-oversampling and oversampling modes but also the freedom to select the phase mode, whether positive or negative.

Navigate to the 'NOS/OS' from the menu and select the preferred sampling mode.

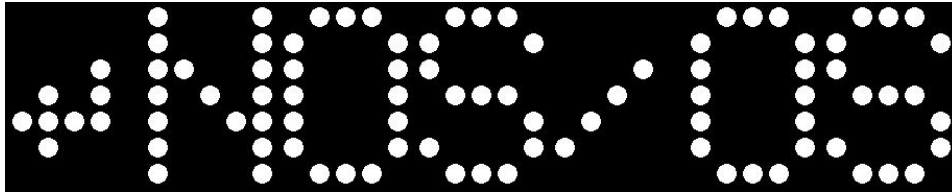

Whether you prefer the purity of Non-oversampling or the enhanced dynamics of oversampling, Harmony μ DAC empowers you to customize your listening experience. Simply select your preferred mode and immerse yourself in the world of versatile sound.

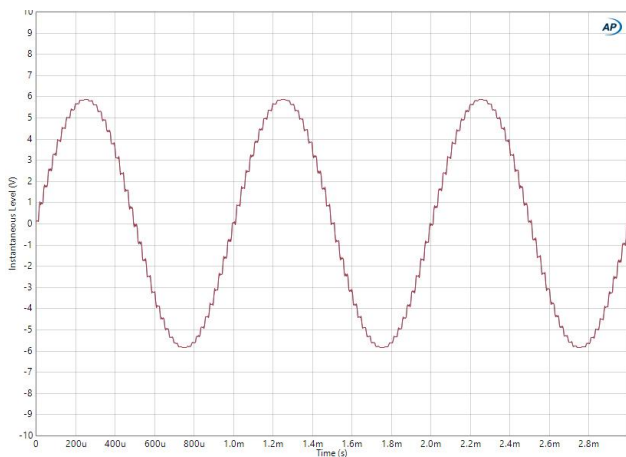
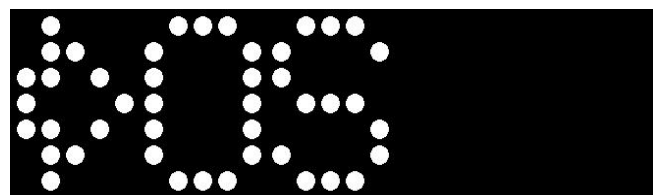
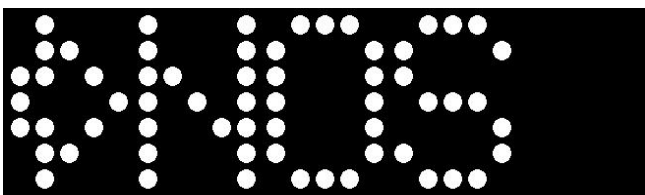

NOS Response ¹

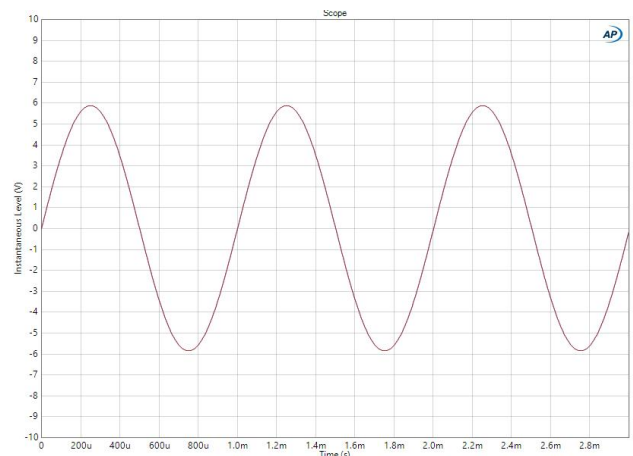

OS Response ¹



Q: I am using OS mode, but why is my DSD input is not being oversampled?

A: NOS/OS has no effect on DSD, so your DSD input is not being oversampled.

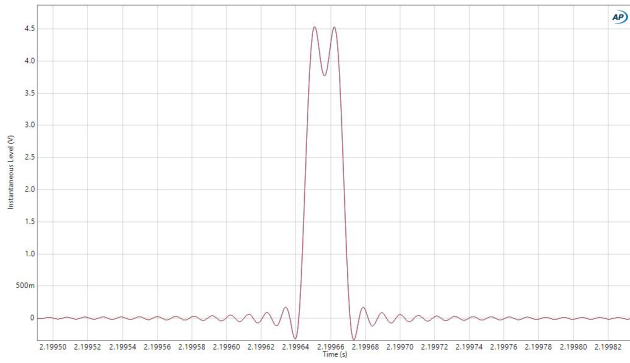

NOS Impulse Response

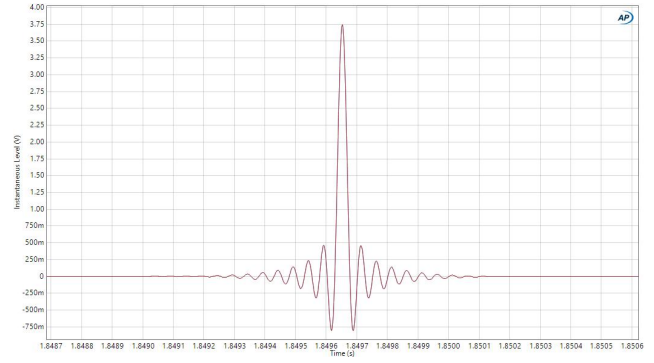

OS Impulse Response

1. Fs: Sine wave 1kHz, Sampling Rate 44.1kHz

The phase mode selection allows you to further customize your audio output, ensuring that every aspect of your listening experience meets your unique preferences. Whether you're seeking enhanced clarity or a warmer sound signature, Harmony μ DAC puts the power of choice in your hands.

Access the 'PHASE' menu and choose your preferred mode.

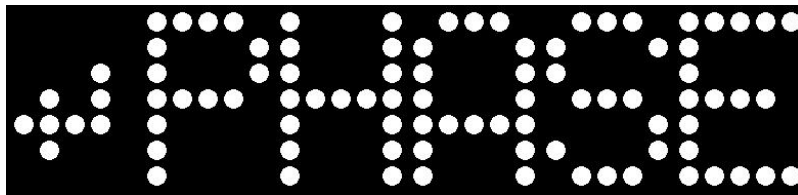

Harmony μ DAC puts you in control, letting you tailor your listening experience to perfection. Select your perfect phase mode—Positive or Negative—and immerse yourself in pure, dynamic sound..

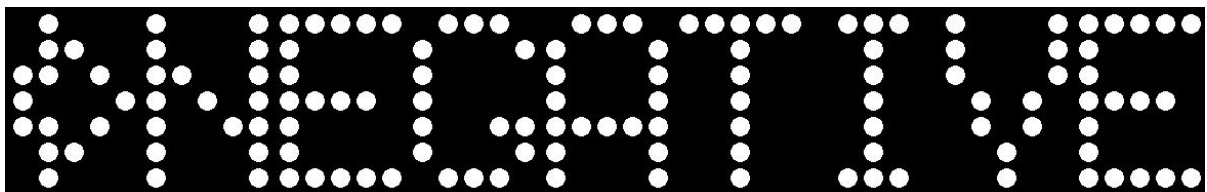
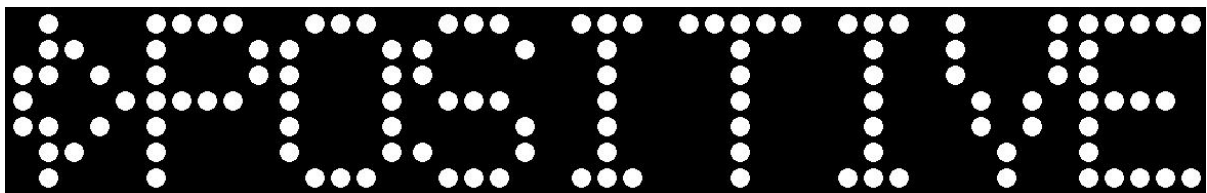

3.4. Remote Control

The remote control for our μ DAC offers convenient customization options to enhance your user experience. This streamlined approach ensures that frequently used functions are just a button press away, saving you time and effort.

Go to the 'REMOTE' menu and select the control selection that best suits your preference.

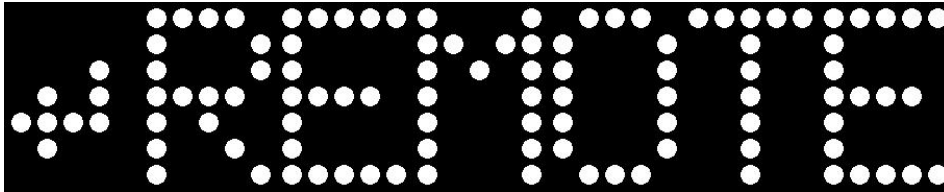

With two function keys, FN1 and FN2, you can assign one of three settings to each key: NOS/OS Mode, Phase Mode, and the I2S mode, allowing for quick access without navigating through the settings menu.

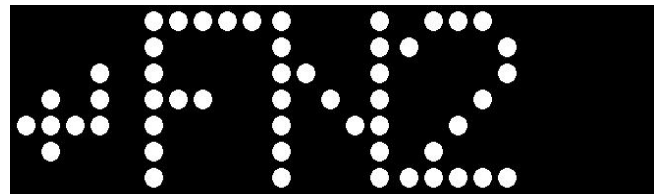
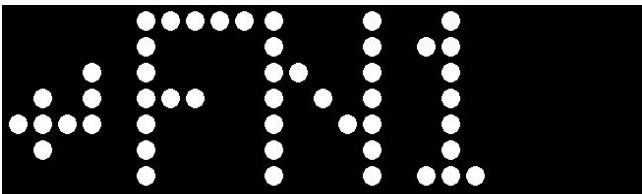

Users can customize their device by selecting one of two distinct shapes: triangle or square. This unique identification system ensures that no two devices share the same shape, preventing any conflicts or miscommunication between multiple devices. By assigning a unique shape to each device, the remote control can accurately distinguish and control the intended device without interference. This enhances the overall user experience by eliminating accidental commands and ensuring seamless operation in multi-device environments.

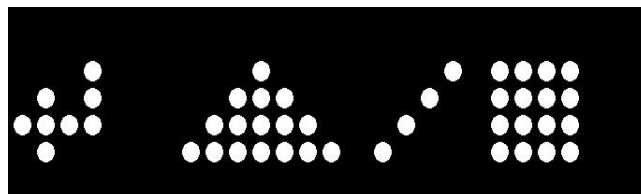

Q: Is there a remote controller provided with the μ DAC?

A: No, the μ DAC does not come with a remote controller. However, it is compatible with the Harmony remote controller for convenient operation.



Q: I don't like the triangle. Can I use the square shape for my μ DAC instead?

A: Yes, you can change the shape of your μ DAC to square, but be sure you also change the shape on your remote control too; otherwise it will not work.

3.5. Display Brightness and Delay Setting

The display brightness and delay settings feature provide you with full control over your viewing experience. With the display brightness setting, you can adjust the brightness of the display to your preference, ensuring optimal visibility in any lighting condition.

Navigate to the 'DISPLAY' from the menu and select the preferred display mode.

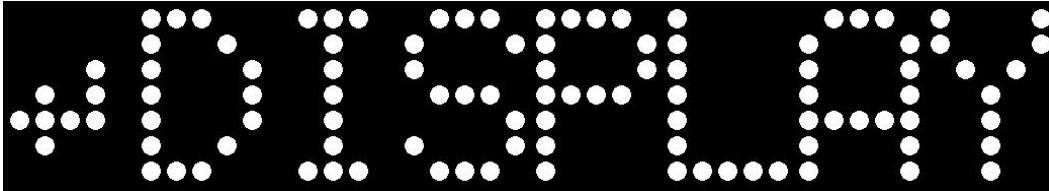

Access to the 'BRT' setting to customize the display brightness according to your preference. You can choose from three levels: Low, Medium, or High, allowing you to optimize visibility based on your environment. A lower brightness setting helps reduce eye strain in dimly lit spaces, while a higher setting ensures better readability in brighter conditions.

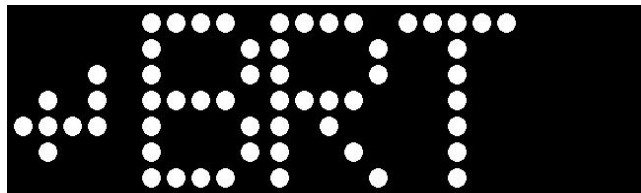

Additionally, our delay function allows the display to automatically dim and turn off after a period of inactivity, conserving energy and minimizing distractions. The delay dim function reduces the brightness to LOW after the selected time period.

Navigate to the 'DELAY' from the 'DISPLAY' menu and select the delay setting.

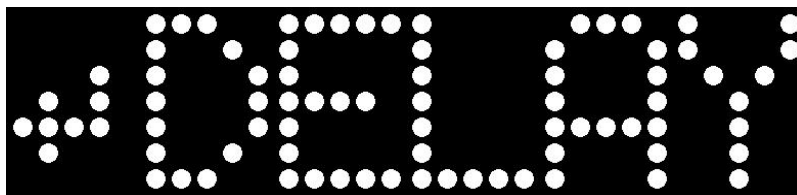

You can personalize the 'DIM' display settings to suit your needs by selecting from four options: 5 seconds, 10 seconds, 20 seconds, or Never. When set to 5s, 10s, or 20s, the display will automatically dim after the chosen duration of inactivity, helping to conserve power and reduce screen glare. If you prefer the display to remain fully lit at all times, you can select 'Never', ensuring continuous visibility. This flexibility allows you to optimize your viewing experience based on your environment and usage preferences.

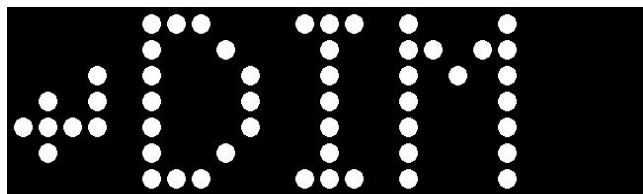

You can adjust the 'OFF' display settings to automatically turn off the screen after 5 seconds, 10 seconds, or 20 seconds of inactivity, helping to conserve power and reduce distractions. If you prefer the display to remain on at all times, you can select 'Never', ensuring continuous visibility. This customization allows you to tailor the screen behavior to your specific needs, whether for power efficiency or uninterrupted display.

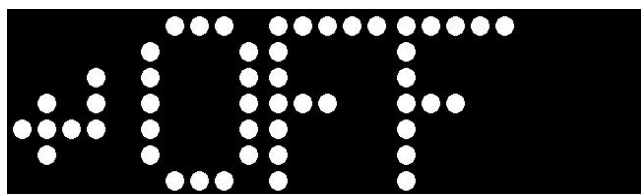

3.6. Display Information Setting

The display information setting feature allows you to control whether additional information such as the currently selected modes for NOS/OS and +pH/-pH is shown or hidden. With this setting, you can choose to display these details or keep the interface clean by hiding them.

Navigate to the 'INFO' from the menu and select the preferred display information mode.

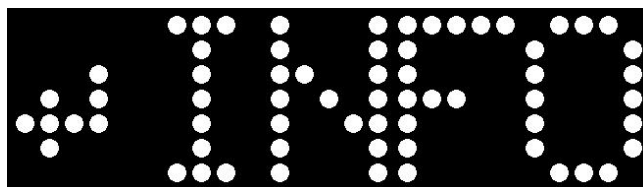

Both delay dim and delay off can be used simultaneously, with the delay off setting taking precedence over the delay dim function. With the combination of both settings, you can reduce the brightness of the display before turning off the display completely.

3.7. I²S Mode

Our innovative I2S system offers eight distinct modes, led by our signature Laiv Audio Mode. Designed in-house for optimal performance, it ensures seamless I2S connectivity between Laiv products. With intelligent auto-configuration, your devices automatically sync to the best mode, eliminating manual setup. Enjoy effortless compatibility and enhanced functionality, exclusive to Laiv.

Navigate to the 'I2S' from the menu and select the preferred I²S mode.

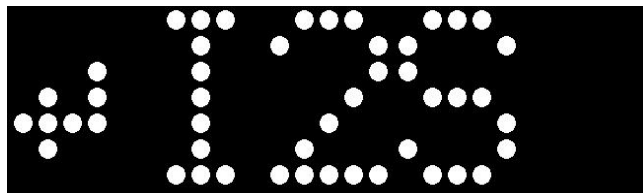

Access the 'MODE' to adjust the I²S mode.

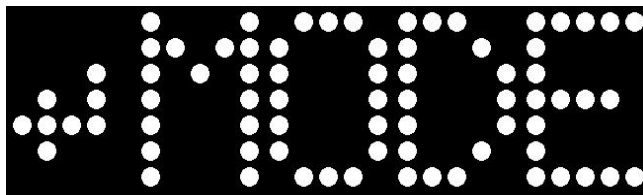

| | Laiv Audio | Mod 1 | Mod 2 | Mod 3 | Mod 4 | Mod 5 | Mod 6 | Mod 7 |
|-------|------------|--------|--------|--------|--------|--------|--------|--------|
| Pin 1 | SDOUT- | SDOUT+ | SDOUT- | SDOUT+ | SDOUT- | SDOUT+ | SDOUT- | SDOUT+ |
| Pin 3 | SDOUT+ | SDOUT- | SDOUT+ | SDOUT- | SDOUT+ | SDOUT- | SDOUT+ | SDOUT- |
| Pin 4 | BCK+ | BCK+ | BCK- | BCK- | BCK+ | BCK+ | BCK- | BCK- |
| Pin 6 | BCK- | BCK- | BCK+ | BCK+ | BCK- | BCK- | BCK+ | BCK+ |
| Pin 7 | LRCK- | LRCK- | LRCK- | LRCK- | LRCK+ | LRCK+ | LRCK+ | LRCK+ |
| Pin 9 | LRCK+ | LRCK+ | LRCK+ | LRCK+ | LRCK- | LRCK- | LRCK- | LRCK- |



Please lower the volume of your system to the lowest audible level before selecting the I²S mode to prevent damage to your loudspeakers.



Q: I have tried all the I²S modes, but none of them are working well with my system. What can I do?

A: Unfortunately, there are no industrial standards for I²S connectivity, so it's possible that none of the modes are compatible with your system.

3.8. I²S Clock

Introducing our I²S clock capability, offering you with remarkable flexibility in your I²S setup. This feature enables you to select between the local μ DAC clock or the I²S clock when utilizing the I²S input. The μ DAC meticulously verifies the compatibility of the I²S clock, only permitting you to opt for the I²S clock if it meets compatibility standard.

Access the 'CLOCK' to adjust the I²S clock.

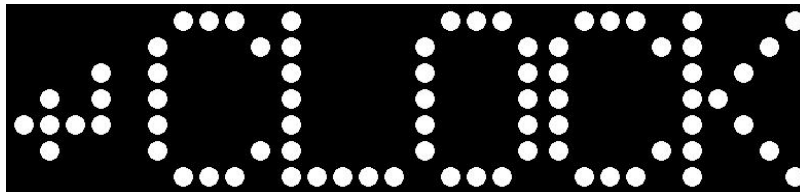

If you select the I²S clock as your preferred clock, in instances where the I²S clock becomes unstable or incompatible, the μ DAC seamlessly reverts to utilizing the local clock. When the I²S clock stabilizes and becomes compatible again, the μ DAC seamlessly reverts back to utilizing the I²S clock. Moreover, when users switch to other digital inputs, the μ DAC seamlessly transitions back to using the local clock. This intelligent system ensures optimal performance and reliability throughout various audio configurations.

3.9. I²S DSD L/R Swap

DSD signals over I²S are not standardized across different manufacturers. As a result, DSD channels may be unintentionally swapped due to variations in internal wiring configurations. This feature allows you to correct such discrepancies by inverting the DSD data lines, ensuring proper left/right channel alignment.

Access the 'DSD L/R SWAP' to do the adjustment.

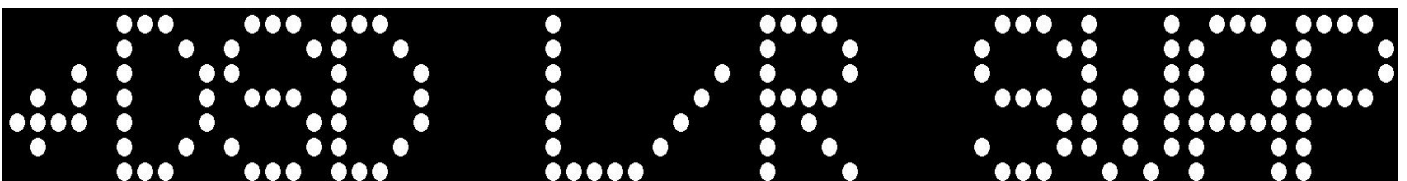

Select Standard if no adjustment is needed for DSD channel alignment. Choose Swap if inversion is required to correctly realign the left and right channels. Always verify using a DSD audio track with distinct left and right channel information.

3.10. Auto Power On Setting

The auto power-on feature allows you to choose how the μ DAC powers up. When this feature is enabled, the μ DAC will automatically power on as soon as it receives power from an external source. If the feature is disabled, the μ DAC will remain off when power is supplied, and you will need to press the power button to turn it on manually. This setting gives users the flexibility to integrate the μ DAC seamlessly into different setups—whether you prefer automated system startup or manual control.

Navigate to the 'POWER' menu and select the preferred Power On mode.

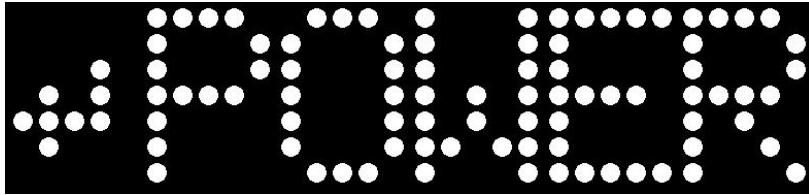

3.11. "About" In The Settings

The "About" settings provide essential information about the firmware version installed. By accessing this menu, users can quickly ascertain the current firmware version installed on their device, ensuring they are up to date with the latest enhancements and features.

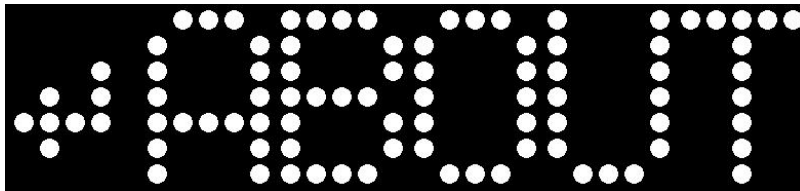

3.12. Factory Reset

The factory reset function lets you quickly restore the μ DAC to its original settings, removing any custom changes you've made. It's useful for troubleshooting or when you want to start fresh. This helps fix issues caused by misconfigurations and ensures the μ DAC works as intended.

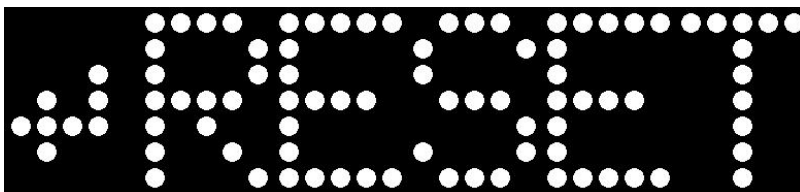



4. Technical Specifications

| | |
|-------------------------------------|--|
| <p>Finish ¹</p> | <div style="display: flex; justify-content: space-around; align-items: center;"> <div style="text-align: center;">  <p>Black Anodized Aluminium</p> </div> <div style="text-align: center;">  <p>Silver Anodized Aluminium</p> </div> </div> |
| <p>Size and Weight ²</p> | <div style="text-align: center;">  <p>Width: 168 mm</p> <p>Depth: 98 mm (Included connectors)</p> <p>Height: 50 mm (Included Spike 10mm)</p> </div> <p>Weight: 0.7kg</p> |

| | |
|-------------------------------------|---|
| Display |  <p>25x7 dot-matrix LED with running text display</p> |
| Chip | Intel® Altera® Cyclone® FPGA |
| Clock | Accusilicon AS318-B Ultra-Low Phase Noise FEMTO Oscillator |
| Digital Inputs | <p>1 x USB</p> <p>1 x Optical</p> <p>1 x Coaxial</p> <p>1 x I²S</p> |
| Analog Outputs | 1 x XLR, maximum at 4 V _{rms} , approx. 82 Ω |
| Supported Formats (Input dependent) | <p>USB - PCM: 44.1kHz - 768kHz DSD: DSD64 - DSD256</p> <p>Optical - PCM: 44.1kHz - 192kHz DSD: DSD64 via DoP only</p> <p>Coaxial - PCM: 44.1kHz - 192kHz DSD: DSD64 via DoP only</p> <p>I2S - PCM: 44.1kHz - 768kHz DSD: DSD64 - DSD256</p> |
| Frequency Response | 20Hz - 20kHz, within ± 0.25 dB ³ |
| THD+N | 0.006 % ³ |
| Crosstalk | ≤ -120 dB ³ |
| Signal to Noise Ratio (SNR) | ≥ 125 dB ³ |
| Dynamic Range | ≥ 110 dB ³ |
| Features | <p>Sleek and Compact design</p> <p>NOS / OS Mode</p> |

| | |
|------------|---|
| | <p>Positive / negative phase</p> <p>Display brightness, delay dim, and delay off</p> <p>8 x I2S Mode with Laiv product auto-configured</p> <p>I2S clock supported</p> <p>Galvanic isolation for enhanced signal purity</p> <p>Laiv Harmony R-2R ladder network architecture</p> <p>Discrete Class A output buffer</p> |
| Controls | <p>Front panel</p> <p>Remote control</p> |
| Power | <p>15VDC/2A , DC 5.5/2.5 mm female</p> |
| In the Box | <p>Welcome card with Quick Start guide</p> <p>Harmony μDAC</p> <p>Power adapter with interchangeable plugs</p> |

1. Colours vary by configuration and manufacturing process.
 2. Size and weight vary by configuration and manufacturing process.
 3. The specification was evaluated using an Audio Precision APx Analyzer under PCM192kHz with 1kHz, A-weighted, SPDIF input, and balanced XLR output conditions.

5. Warranty and Contact Information

5.1. Warranty Terms

Warranty Period: 24 months from the date of purchase.

What's Covered: Defects in materials and workmanship.

What We'll Do: Repair your product if it has any defects during the warranty period.

How to Get Service:

- Register the warranty of your product within 3 months of the date of purchase at <https://www.laiv.audio/warranty-registration>
- To obtain warranty service, the customer must contact the Company's customer service department at info@laiv.audio.
- Proof of purchase, such as the original purchase receipt and warranty card, may be required.
- The customer may be responsible for shipping the defective Product to the Company's designated service center.

What's Not Covered:

- Import duties or taxes whenever applicable.
- Damage resulting from misuse, abuse, or unauthorized modifications or repairs.
- Normal wear and tear.
- Consumable parts, such as batteries, unless otherwise stated

Limitation of Liability: Our responsibility limited to repairing or replacing the parts.

Refer to the QR or <https://www.laiv.audio/terms-and-conditions#warranty> for the complete warranty terms.



5.2. Contact Information

For any inquiries or support related to this product, please don't hesitate to contact our Customer Support Team:

Email : support@laiv.audio

Website : <https://www.laiv.audio/contact>

We're here to assist you with any questions or concerns you may have regarding the product.